

# WashBasic

## Dosing System for Professional Laundry Machines



### Contents:

1. GETTING STARTED.....	2
2. INSTALLATION .....	3
3. ELECTRICAL CONNECTIONS.....	6
4. STARTUP, RUNNING AND PROGRAMMING MODE .....	7
5. PROGRAMMING MENU .....	8
6. ALARMS .....	10
7. MAINTENANCE & ACCESSORIES.....	10
8. TROUBLESHOOTING .....	10

## 1. GETTING STARTED

### 1.1 WELCOME

Get ready for a whole new experience. **WashBasic** has a fresh, new look and it's easier than ever to use.

This proven chemical dispensing system is engineered to dispense one or two chemicals. Chemical feeds either by a trigger signal directly from the washer or manually by the operator with the activating switches on the front cover. It is also possible to activate the unit dispensing with a remote switch (optional) to be connected to the **WashBasic**. A unique "Product Lockout" feature helps you control costs and product consumption.

This book explains how to install and set up the **WashBasic** and where to turn for help so you can enjoy the most intuitive dosing system yet.

 Please review this manual carefully. Pay particular attention to warnings and precautions. Always follow good safety procedures, including the use of proper clothing, eye and face protection.

 Please read through entire manual and choose operating mode before you begin installation.

### 1.2 WHAT'S IN THE BOX?

Before you start, check that your box contains the following items:

- **WashBasic** system;
- Instruction manual;
- Mounting kit;
- PVC tube: 8x12 mm (3/8"), 4 m (16.4 ft) each pump.

### 1.3 TECHNICAL FEATURES

- Power Supply: 100-240 Vac @ 50-60 Hz with main switch
- Maximum Power Consumption: 15W
- Protection of the System: IP54. The gasketed enclosure on the **WashBasic** is highly water resistant and the electronics are further protected within the enclosure
- Fuse: 1,25A T 250V, 5X20 mm
- Weight: 3 kg (6.61 lb)
- Dimensions (L x D x H): 205 x 135 x 200 mm (8.07 x 5.31 x 7.87 in)

These symbols on or inside the unit mean:



Danger: high voltage.



Caution, replace fuse with same type and value



Power "ON" (supply)



Power "OFF" (supply)

## 1.4 WARNINGS



**Caution! Risk of electrical shock**



Check the voltage of the main power source and make sure that it matches the available input voltage (100-240 Vac) of the transformer inside the WashBasic.



Adding or replacing pumps, pump tubes or other components should only be performed by qualified personnel



All electrical connections to the WashBasic should first be verified with a meter. Application of incorrect voltage will permanently damage the unit and is not covered under warranty. Avoid wiring to any power source that has large fluctuations in voltage and/or is prone to surges. Refer to the wiring diagram in this manual for all power and signal connections.



For all connections, please refer to the circuit board schematic contained in this manual.



Check the model of the equipment you have purchased for the references about installation, setting and programming.



**CAUTION:** The WashBasic has high voltage connected to the transformer. Always disconnect power when servicing the unit.



**CAUTION:** During installation and electrical connections remove all power from the laundry machine.



Failure to follow these instructions may lead to personal injury, damage to the product or poor product performance.

## 1.5 MATERIALS REQUIRED DURING INSTALLATION

- Two pole wire: 2x0.75 - H-05 VVF (qty 2; length 2 mt - for trigger signal);
- Two pole wire: 2x1.5 - H-05 VVF (qty 1; length 2 mt - for power supply);
- 4x6 mm copper tubing (qty 1; length 2 mt - for water solenoid valve).



The lengths indicated above are for typical installations. Your installation may require different lengths.



An installation kit is available.

## 2. INSTALLATION

Mount the unit on a nearby wall (using suitable hardware) to the laundry machine. Try to keep the unit within one meter from the final rinse line to avoid long tubing runs.

Locate the **WashBasic** as close to the chemical product tanks as possible in order to maximize both your motor and tube life.

Check all applicable plumbing and electrical codes before proceeding with the installation. This will help to ensure that the system is installed in safe and suitable manner. A wiring schematic of the laundry machine should be used as reference for making electrical connections, this is typically provided by the laundry machine manufacturer if one cannot be located on the machine itself.

### 2.1 MOUNTING THE SYSTEM

Apply the panel unit system with the brackets and screws supplied:

- Determine a suitable location for the system;
- Using the bracket as a template, mark and drill holes for bolting the system to the wall;
- Insert the anchors in the holes;
- Bolt the bracket in place with the hardware provided;
- Mount the system with the bracket as the picture below;
- Open the Cabinet Front, unscrewing the upper screws by ¼ of a turn.

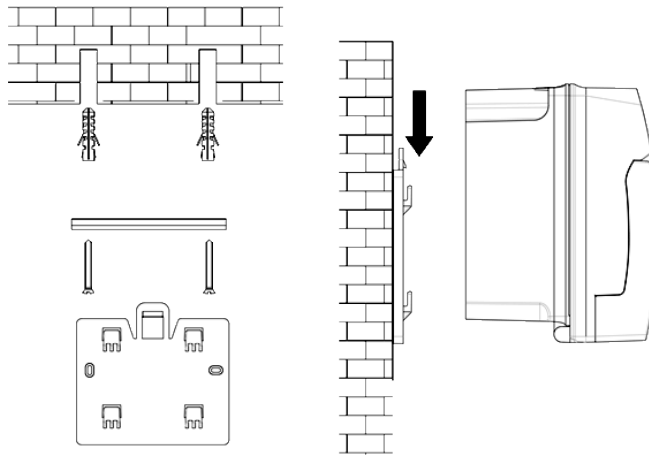
**Picture 1**

## 2.2 PLUMBING

### 2.2.1 Liquid product plumbing:

Connect 8X12 mm (3/8") PVC tubing from the output (right) side of the pump to the injection point.  
Connect 8x12 mm (3/8") PVC tubing from the chemical source to the suction (left) side of the pump.

### 2.2.2 Solid product plumbing:

A powder or solid type feeder (not provided) should be used for dispensing dry detergent products. Follow the instructions included with the detergent feeder for installation, and recommended water temperature/pressure. Make sure that the detergent feeder (bowl) is located in a position on the wall that allows the feeding of the detergent in the laundry machine through gravity.

- Cut a suitable length of 1/4" OD copper tubing (not provided) and connect between the input side of the water solenoid valve and the water source;
- Cut a suitable length of 1/4" OD copper tubing (not provided) and connect between the output of water solenoid to a powder or solid detergent feeder;
- Cut a suitable length of tubing (not provided) and connect between the output of detergent feeder to the elbow connector;

Carefully tighten the compression nuts on the water solenoid; over tightening may cause solenoid to leak. Tighten connections to the water source and detergent feeder as needed.

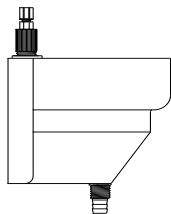
**Picture 2**

- ⓘ **The water solenoid valve does not have a set direction for input/output.**
- ⓘ **Always use the foot filter and make sure that it reaches the bottom of the container. Periodically check and clean the filter of buildup or debris.**

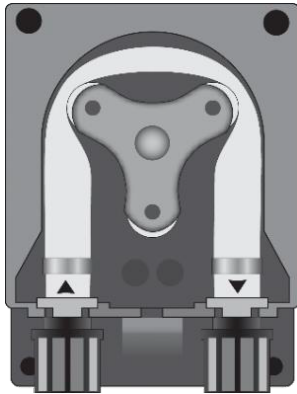
**HOSE REPLACEMENT**

Open the pump's lid and release the hose by pulling the left connector upward.

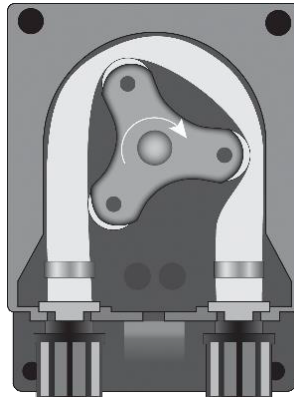

Position the roller at 7h15, turning it in the direction of the circular arrow.

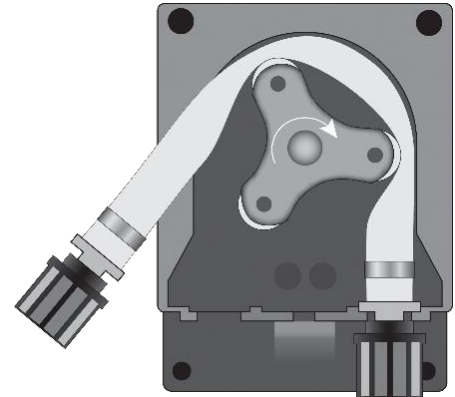

Completely release the left connector, holding it taut towards the outside, and turn the roller in the direction of the circular arrow so that the hose is freed up to the right connector.

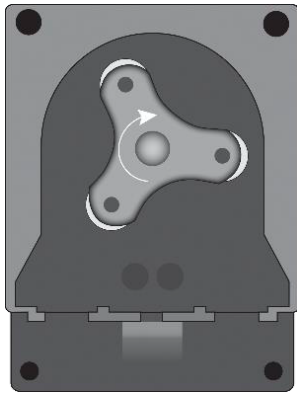

Position the roller at 7h05, turning it in the direction of the circular arrow.

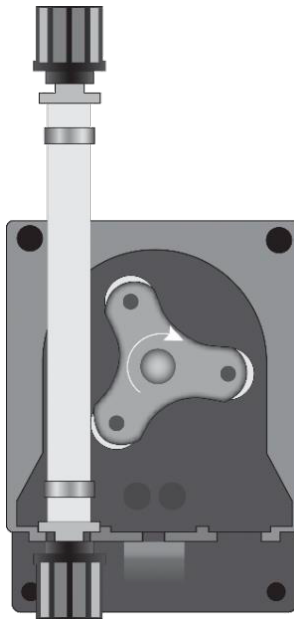

Insert the left connector into the relative housing and pass the hose under the roller's guide. Turn the roller in the direction of the circular arrow, simultaneously accompanying the hose into the pump's head, until the right connector is reached.

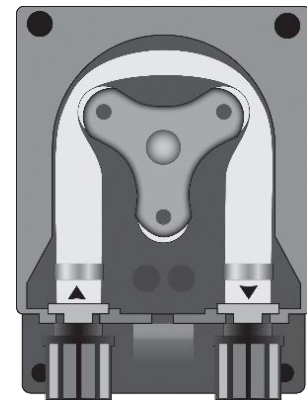

Close the pump's lid and press its surface hard so that it is properly locked into place.

### 3. ELECTRICAL CONNECTIONS (Qualified service personnel only)



**CAUTION:** The WashBasic has high voltage connected to the transformer. Always disconnect power when servicing the unit.



All electrical connections to the WashBasic system should first be verified with a meter. Application of incorrect voltage will permanently damage the unit and is not covered under warranty. Avoid wiring to any power source that has large fluctuations in voltage and/or is prone to surges. Refer to the wiring diagram in this manual for all power and signal connections. All wiring must conform to local electrical codes.

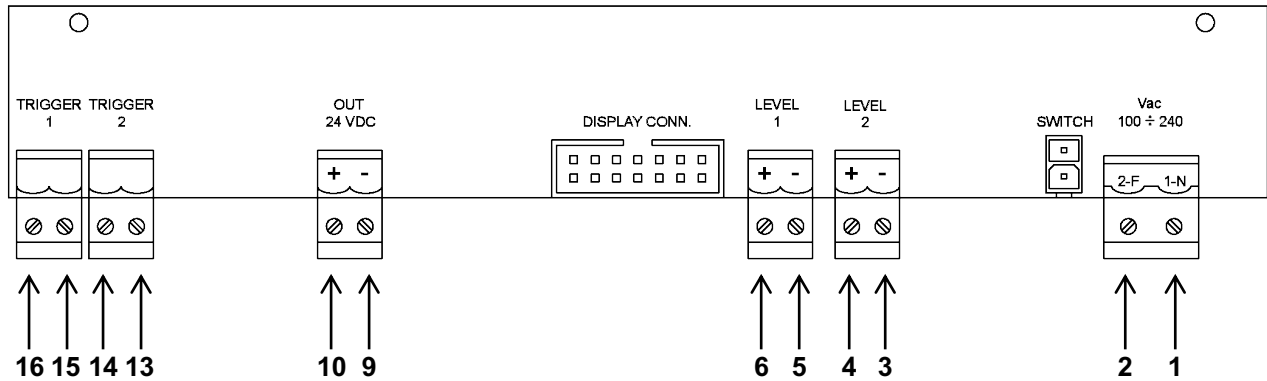

CONNECTOR	SIGNAL	TYPE OF SIGNAL	TYPE
1-2	<b>Power Supply</b>	VAC (100-240)	INPUT
3-4	<b>Level 2</b>	Dry Contact	INPUT
5-6	<b>Level 1</b>	Dry Contact	INPUT
9-10	<b>Alarm Output</b>	OUT 24 VDC	OUTPUT
13-14	<b>Trigger 2</b>	VAC (12-240)	INPUT
15-16	<b>Trigger 1</b>	VAC (12-240)	INPUT

## 4. STARTUP, RUNNING AND PROGRAMMING MODE

### 4.1 START UP

When power is switched on, the display will briefly show the firmware code and its revision number and go through a self-test routine. Then it will show the default display:

Ready Ready

### 4.2 RUNNING MODE

Running mode will always show the ongoing phase for each pump on the display:

- When in standby 

Ready Ready
- As the trigger is present and accepted 

Trig Trig
- Time decreasing in delay mode 

Del010 Del005
- Time decreasing in dosing mode 

Dos018 Dos011
- Time decreasing in locked mode 





Lck000 Lck000

If only one program is set, the system will not show the program parameter. If multiple programs are set the running mode will be as follows:

- When in standby 

Ready P1 Ready

By using the buttons in running mode, it is possible to:

- Activate the dosage of the right pump by pressing ;
- Activate the dosage of the left pump by pressing ;
- Change the program from 1 to 9, if multiple programs are set, by pressing  once;
- Access the Setup/Setting menu by pressing  for more than 3 seconds.

### 4.3 PROGRAMMING MODE

To access the programming menu, when in standby, press  for more than 3 seconds then use   and  to select one of the following available options: Prime, Setup, Setting, Escape.













When in programming mode, press  for more than 3 seconds to exit and return to the standby mode at any time.

#### Notes:















































- The user will be asked to insert the Password **only if password is different than 0000**, otherwise the access to the programming menu will be free.
- Once the password is set and after pressing  for 3 seconds to access to programming menu, if buttons are not used for more than 20 seconds, the system will automatically exit the programming mode.

## 5. PROGRAMMING MENU

### 5.1 PRIMING INSTRUCTIONS











































	DISPLAY READING	DESCRIPTION
1	Ready Ready	From standby, press  for more than 3 sec. to access the programming menu.
2	Password 0000	If the password is set, use   to insert the password and press  to confirm.
3	Prime	Use   to select <b>Prime</b> and press  to confirm.
4	Prime ▼ ▲ Prime	Press and hold  to prime the DETERGENT pump. Press and hold  to prime the RINSE pump. Press  to confirm and to return to the previous menu.
5	Escape	To exit the programming mode, use   to select <b>Escape</b> and press  to confirm.

### 5.2 SETUP MENU

	DISPLAY READING	DESCRIPTION
1	Ready Ready	From standby, press  for more than 3 sec. to access the programming menu.
2	Password 0000	If the password is set, use   to insert the password and press  to confirm.
3	Setup	Use   to select <b>Setup</b> and press  to confirm.
4	Pumps Dosage	If the option <b>Dosage Method</b> in <b>Setting menu</b> is set to <b>Volume</b> : Use   to select <b>Pumps Dosage</b> and press  to confirm.
5	000s Dos 000s	Press  to start/stop the dosage. Press  to decrease/adj. time up to "0". Press  to confirm and move to the next option.
6	000s Dos 000s	Press  to start/stop the dosage. Press  to decrease/adj. time up to "0". Press  to confirm and move to the next option.
7	Pumps Time	If the option <b>Dosage Method</b> in <b>Setting menu</b> is set to <b>Time</b> : Use   to select <b>Pumps Time</b> and press  to confirm.
8	000s Time 000s	Press and hold   to scroll the value (up to 999s). Press  to confirm and to move to the next option.
9	000s Time 000s	Press and hold   to scroll the value (up to 999s). Press  to confirm and to move to the next option.
10	Pumps Delay	Use   to select <b>Pumps Delay</b> and press  to setup the delay.
11	000s Del 000s	Press and hold   to scroll the value (up to 999s). Press  to confirm and to move to the next option.
12	000s Del 000s	Press and hold   to scroll the value (up to 999s). Press  to confirm and to move to the next option.
13	Pumps Lockout	Use   to select <b>Pumps Lockout</b> and press  to setup the lockout.
14	000m Lck 000m	Press and hold   to select the value (up to 999m). Press  to confirm and to move to the next option.
15	000m Lck 000m	Press and hold   to select the value (up to 999m). Press  to confirm and to return to the previous menu.
16	Escape	To exit the programming mode, use   to select <b>Escape</b> and press  to confirm.





## 5.3 SETTING MENU

	DISPLAY READING	DESCRIPTION
1	Ready Ready	From standby, press  for more than 3 sec. to access the programming menu.
2	Password 0000	If the password is set, use   to insert the password and press  to confirm.
3	Setting	Use   to select <b>Setting</b> and press  to confirm.
4	Password Set	Use   to select <b>Password Set</b> and press  to confirm.
5	Pass. Set 0000	Use   to set the new password. Press  to confirm and to move to the next option.
6	Programs Qty	Use   to select <b>Programs Qty</b> and press  to confirm.
7	Prog. N 1	Use   and  to select <b>from 1 to 9</b> programs. Use   to change the programs qty. Press  to confirm and to move to the next option.
8	Washer Trigger	Use   to select <b>Washer Trigger</b> and press  to confirm.
9	Trigger	Use   to select between <b>12-230V</b> and <b>80-230V</b> . Press  to confirm and to move to the next option.
10	Language	Use   to select <b>Language</b> and press  to confirm.
11	Lan. English	Use   to select between <b>English, French, Italian, Spanish</b> . Press  to confirm and to move to the next option.
12	Washer solenoid	Use   to select <b>Washer solenoid</b> and press  to confirm.
13	Wash. sole. NC	Use   to select between <b>NO</b> and <b>NC</b> . Press  to confirm and to move to the next option.
14	Dosage method	Use   to select <b>Dosage method</b> and press  to confirm.
15	Dosage Volume	Use   to select between <b>Volume</b> and <b>Time</b> . Press  to confirm and to move to the next option.
16	Buttons enable	Use   to select <b>Buttons enable</b> and press  to confirm.
17	Butt. Enable Yes	Use   to select <b>Yes</b> or <b>No</b> . Press  to confirm and to move to the next option.
18	Trigger filter	Use   to select <b>Trigger filter</b> and press  to confirm.
19	Trig. Filt. 03s	Use   to set a value between <b>0-99s</b> . Press  to confirm and to move to the next option.
20	Escape	To exit the programming mode, use   to select <b>Escape</b> and press  to confirm.

## 5.4 SYSTEM RESET

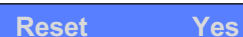
To reset the system, press  for 15 seconds. The system will show:



Use   to select **Yes** and press  to confirm.

## 6. ALARMS

Alarm Message	Alarm Relay	Buzzer	Pump Block	Restore Condition
Par Err PressEnt	NO	NO	YES	Restore default values by pressing  and reprogram the system according to specific needs.
Pump 1 LEVEL	YES	YES	YES	Refill with product to clear the alarm.
Pump 2 LEVEL	YES	YES	YES	Refill with product to clear the alarm.
M.Block	YES	YES	YES	System restart. Check for hardware malfunction.

## 7. MAINTENANCE & ACCESSORIES

### 7.1 MAINTENANCE

Routine maintenance on the **WashBasic** unit includes replacing worn out pump tubes and keeping the unit clean. Repairs to the unit involve modular component replacements. This minimizes spare parts inventory requirements and speeds up the service process in the field.

#### SQUEEZE TUBE REPLACEMENT

Replace squeeze tubes on regular maintenance intervals. A planned preventive maintenance schedule will insure replacement before the tube fails. In the event the tube does rupture, clean all product from pump with a damp cloth.

- Disconnect the power supply and open the blue transparent lid of the **WashBasic**;
- Remove the old tube and insert the new squeezing tube;
- Close the blue transparent lid of the **WashBasic** and make sure the lid clicks into its seat.

### 7.2 ACCESSORIES

It is possible to connect a remote control to the system.

## 8. TROUBLESHOOTING

	Problem	Action
1	<b>Power light does not illuminate</b>	<ul style="list-style-type: none"> <li>• Check fuses on the circuit board.</li> <li>• Check input terminals on board for correct input voltage. Refer to the circuit board diagram.</li> </ul>
2	<b>Pump(s) or solenoid will not activate</b>	<ul style="list-style-type: none"> <li>• Check pump output terminals for loose screws and disconnected wires.</li> <li>• Check for proper voltage across motor windings (or solenoid contacts).</li> <li>• Check for obstruction in pump head (or solenoid).</li> </ul>
3	<b>Too much or too low chemical</b>	<ul style="list-style-type: none"> <li>• Check the programmed quantity.</li> </ul>

## 9. Console

The function **Button Enable** have to be enabled in order that the console can work.



## 10. Technical assistance

For technical assistance please contact:

Seko Spa  
Via Salaria Km. 92,200  
02015 S.Rufina - Rieti (Italy)  
Phone: +39 0746 605801 - Fax: +39 0746 607072  
Website: <http://www.seko.com>